

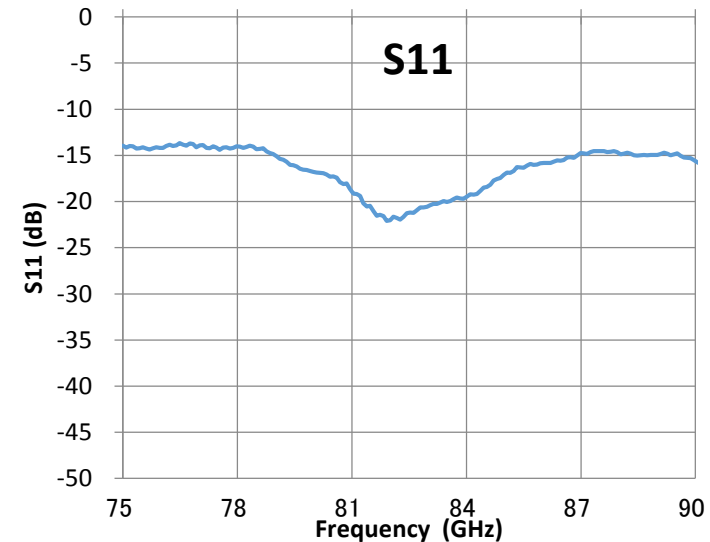

RF Probe Model: TP90-WR12 (Preliminary)

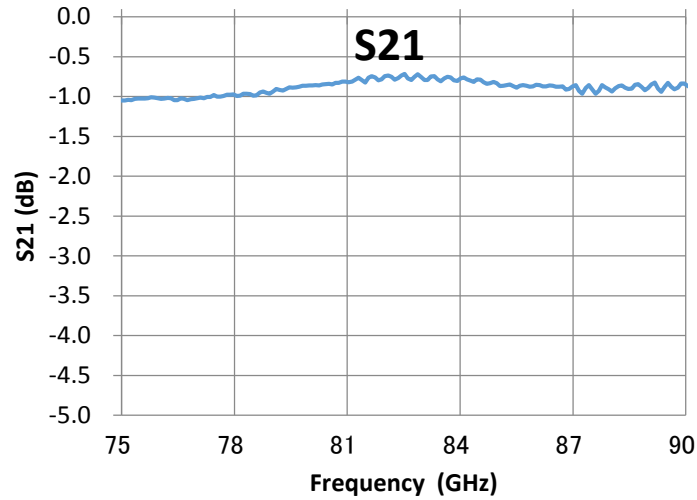

Electric Performance

Characteristic impedance	50 ohm
Frequency range	60 to 90GHz
Insertion loss (Typ. GSG-150µm)	-2.5dB
Return Loss (Typ. GSG-150µm)	-10dB
DC voltage	100V
DC current	1A
RF Power @ 10GHz max	5W
Contact resistance on Au	0.05 ohm

Mechanical Performance

Waveguide Flange	WR12
Available Pitch	50 to 250m (25um step)
Available Configuration	GSG
Probe Material	Nickel Alloy
Body Material	Aluminum Alloy
Contact pressure @2mil Over travel	20g
Contact Cycle (Auto Probe Mode: OD 1mil)	1M
XY position error	Max 10um
Planarity error	Max 10um
Scribing mark (Width)	30um

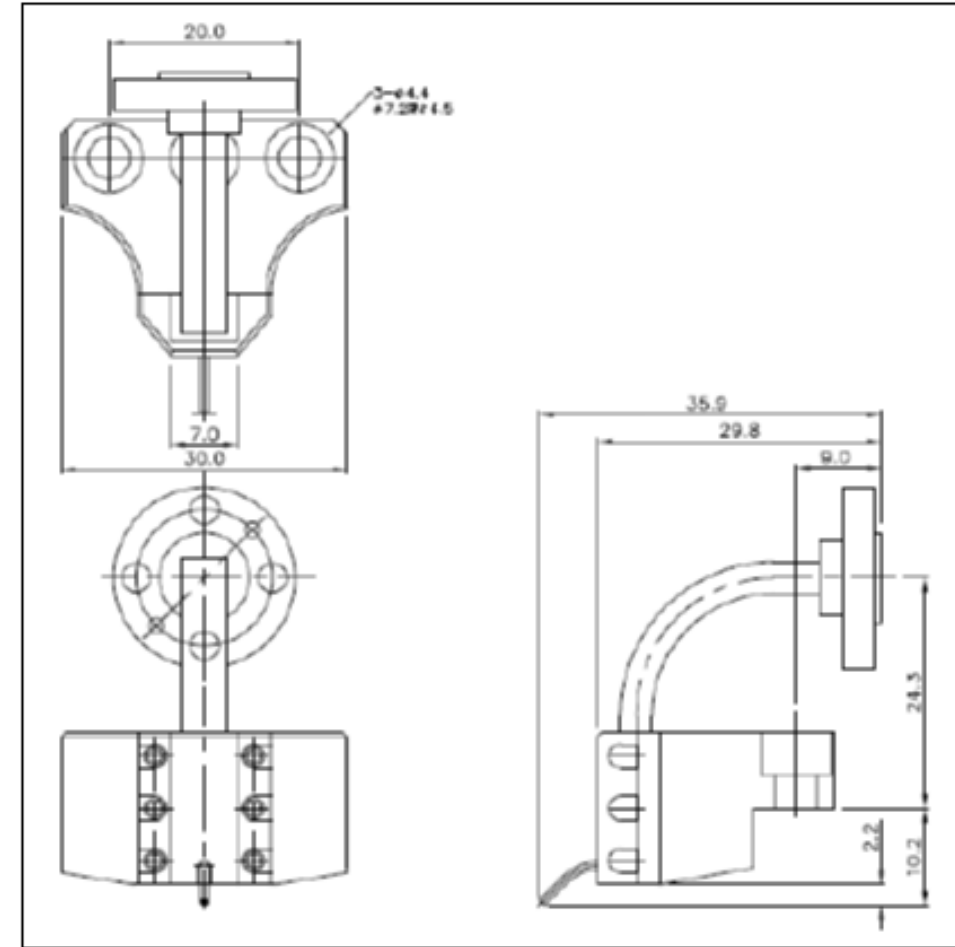

Unit: mm
Tolerance: +/-0.25